

Flared Connectors - All 16 ga. Aluminized Steel

O.D. -- A -- in (mm)	I.D. -- B -- in (mm)	O.D. -- C -- in (mm)	-- D -- in (mm)	E	-- F -- in (mm)	Flared Connector	V-Band Clamp	Application
3.00 (76)	3.02 (77)	3.62 (92)	4.00 (102)	22°	0.75 (19)	P207619	P206604	DD 6V 71
3.50 (89)	3.63 (92)	4.25 (108)	4.00 (102)	22°	0.75 (19)	P207581	P206605	8V-71-VT-555
4.00 (102)	4.02 (102)	4.75 (121)	4.00 (102)	22°	0.75 (19)	P207620	P206606	6 71-12V 71



P207619

O.D. -- A -- in (mm)	I.D. -- B -- in (mm)	O.D. -- C -- in (mm)	-- D -- in (mm)	E	-- F -- in (mm)	Flared Connector	V-Band Clamp
3.50 (89)	3.52 (89)	4.19 (106)	4.75 (121)	45°	2.12 (54)	P207568	P206605
4.00 (102)	4.02 (102)	4.70 (119)	4.75 (121)	45°	2.50 (64)	P207567	P206606
5.00 (127)	5.02 (128)	5.70 (145)	4.75 (121)	45°	3.00 (76)	P207566	P206607



P207568, P207567, or P207566

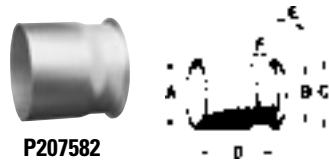

P207582

O.D. -- A -- in (mm)	I.D. -- B -- in (mm)	O.D. -- C -- in (mm)	-- D -- in (mm)	E	-- F -- in (mm)	Flared Connector	V-Band Clamp	Application
4.00 (102)	3.63 (92)	4.25 (108)	3.81 (97)	22°	0.75 (19)	P207582	P206605	8V 71

I.D. / O.D. -- A -- in (mm)	O.D. -- C -- in (mm)	-- D -- in (mm)	E	Flared Connector	V-Band Clamp
3.00 (76) ¹	3.75 (95)	1.50 (38)	20°	P206612	P206604
	3.92 (100)	2.25 (57)	20°	J009479	J009611
3.50 (89) ¹	4.19 (106)	1.50 (38)	22°	P206613	
3.50 (89) ²	4.29 (109)	1.50 (38)	22°	J009391	P206605
4.00 (102) ¹	4.75 (121)	1.50 (38)	22°	P206614	P206606
5.00 (127) ²	5.50 (140)	5.25 (133)	45°	J009393	
	5.69 (145)	3.00 (76)	22°	P206615	P206607
	5.86 (149)	5.00 (127)	20°	J009629 ³	



P206614



J009629

Adapter with
Pyrometer Fitting
(1/4" NPT)



- 1 - I.D. Dimension
- 2 - O.D. Dimension
- 3 - Adapter has pyrometer fitting

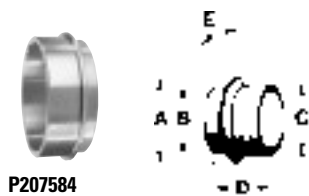

P207584

Lipped Flange

O.D. -- A -- in (mm)	I.D. -- B -- in (mm)	O.D. -- C -- in (mm)	-- D -- in (mm)	E	Flange	V-Band Clamp	Application
5.01 (127)	4.25 (108)	4.80 (122)	1.94 (49)	20°	P207584	P210110	Air Research Turbo

Marmon Flanges & Flares NEW

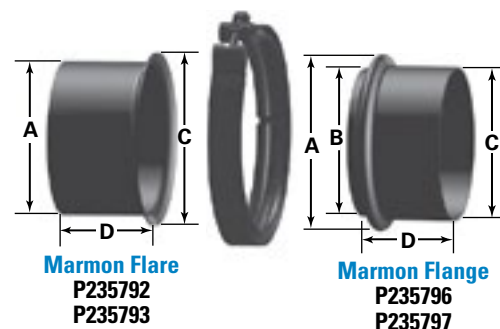

Marmon Flare
P235792
P235793

Marmon Flange
P235796
P235797

Join parts together for leakproof and serviceable connections with a V-Band Clamp. All components made from 304 SS.

	O.D. -- A -- in (mm)	I.D. -- B -- in (mm)	O.D. -- C -- in (mm)	-- D -- in (mm)	Part No.	V-Band Clamp
Marmon Flare	4.00 (102)	—	4.63 (118)	3.00 (76)	P235792	P206606
	5.00 (127)	—	5.63 (143)	3.00 (76)	P235793	P206607
Marmon Flange	4.72 (120)	3.80 (97)	4.00 (102)	3.00 (76)	P235796	P206606
	5.79 (147)	4.96 (126)	5.00 (127)	3.00 (76)	P235797	P206607

I.D. - I.D.

Reduces O.D. pipe of different sizes. 16 gauge aluminized steel.

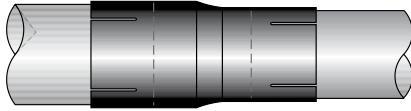

-- I.D. -- in mm	-- I.D. -- in mm	Length in mm	Part Number
2.50 64	2.00 51	6.00 152	P207382
2.75 70	2.50 64	6.00 152	P207385
3.00 76	2.50 64	6.00 152	P206313
	2.75 70	6.00 152	P207386
3.50 89	3.00 76	6.00 152	P206314
4.00 102	3.00 76	6.00 152	P206315
	3.50 89	8.00 203	P206316
5.00 127	4.00 102	6.00 152	P206317
6.00 152	5.00 127	8.00 203	P206318



I.D. - O.D.

Reduces larger O.D. pipe to smaller I.D. pipe. Also used as muffler bushing or manifold outlet. 16 gauge aluminized steel.



-- I.D. -- in mm	-- O.D. -- in mm	Length in mm	Part Number
2.50 64	2.00 51	6.00 152	P207397
3.00 76	2.50 64	6.00 152	P206319
	2.75 70	6.00 152	P207401
3.50 89	3.00 76	6.00 152	P206320
4.00 102	3.00 76	6.00 152	P206321
	3.50 89	6.00 152	P206322
4.50 114	4.00 102	6.00 152	J190046
5.00 127	4.00 102	6.00 152	P206323
6.00 152	5.00 127	6.00 152	P207402



O.D. - I.D.

Reduces larger I.D. pipe to smaller O.D. pipe. 16 gauge aluminized steel.



-- O.D. -- in mm	-- I.D. -- in mm	Length in mm	Part Number
2.50 64	2.00 51	6.00 152	P207389
2.50 64	2.25 57	4.00 102	J008942
3.00 76	2.50 64	6.00 152	P206324
3.50 89	3.00 76	6.00 152	P206325
4.00 102	3.00 76	6.00 152	P206326
	3.50 89	6.00 152	P206327
4.50 114	4.00 102	6.00 152	J190041
5.00 127	4.00 102	6.00 152	P206328
6.00 152	5.00 127	6.00 152	P207394



Connectors

I.D. - I.D.

Connects O.D. pipes of the same size. 16 gauge aluminized steel.

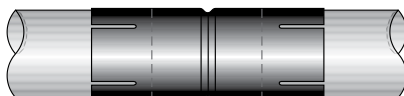

--- I.D. --- in mm	-- Length -- in mm	Part Number
2.00 51	6.00 152	P207405
2.50 64	6.00 152	P206371
3.00 76	6.00 152	P206372
3.50 89	6.00 152	P206373
4.00 102	6.00 152	P206374
5.00 127	6.00 152	P206375
6.00 152	6.00 152	P207408

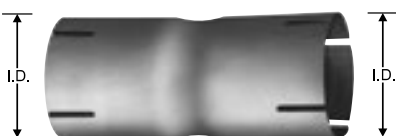

I.D. - O.D.

Connects O.D. and I.D. pipes of the same size. 16 gauge aluminized steel.

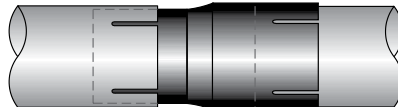

I.D.-O.D. in mm	-- Length -- in mm	Part Number
2.00 51	6.00 152	P207411
2.50 64	6.00 152	P206366
2.75 70	6.00 152	P207413
3.00 76	6.00 152	P206367
3.50 89	6.00 152	P206368
4.00 102	8.00 203	P206369
5.00 127	8.00 203	P206370
6.00 152	6.00 152	P207414



O.D. - O.D.

Connects I.D. pipes of the same size. Also used on manifold outlet. Connector has tube stop. 16 gauge aluminized steel.

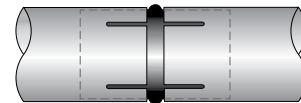

O.D.-O.D. in mm	-- Length -- in mm	Part Number
2.50 64	6.00 152	P206361
3.00 76	6.00 152	P206362
3.50 89	6.00 152	P206363
4.00 102	8.00 203	P206364
5.00 127	8.00 203	P206365



O.D. - O.D.

Reduces I.D. pipe of different sizes. 16 gauge aluminized steel.

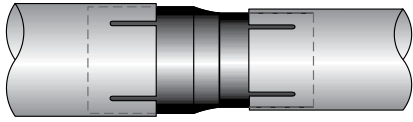

-- O.D. -- in	mm	-- O.D. -- in	mm	Length in	mm	Part Number
3.00	76	2.50	64	6.00	152	J190042
3.50	89	3.00	76	6.00	152	J190044
4.00	102	3.00	76	6.00	152	J009648
		3.50	89	6.00	152	J190045
5.00	127	4.00	102	8.00	203	J009649
6.00	152	5.00	127	8.00	203	J009650



Tilt Cab Ball & Cone Connectors

- 16 gauge aluminized steel construction



Ball Connector
P205976 - 4" Pipe I.D.
P206300 - 5" Pipe I.D.



Cone Connector
P205979 - 4" Pipe O.D.
P206299 - 5" Pipe O.D.

Standard "Y" Adapter Pipe

- 16 gauge aluminized steel construction

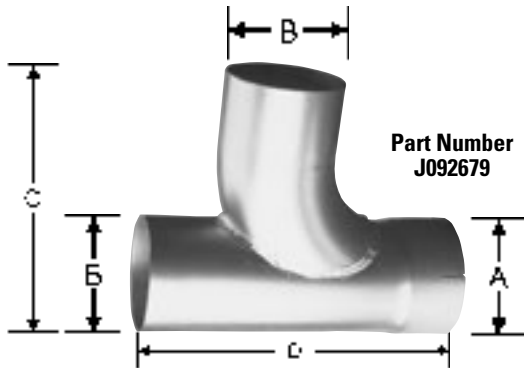

- A (I.D.) - in	mm	- B (O.D.) - in	mm	----- C ----- in	mm	----- D ----- in	mm	Part Number
4.00	102	4.00	102	9.00	229	14.00	356	J092679
5.00	127	5.00	127	10.50	267	15.00	381	J092689

Splitter Tee Adapter

- Converts single exhaust pipe to dual exhaust system
- 16 gauge aluminized steel

(A) in	mm	(B) in	mm	Truck ID (C) in	mm	Leg OD (D) in	mm	Part Number
17.50	445	12.00	305	4.00	102	4.00	102	P206297
26.00	660	14.00	356	5.00	127	5.00	127	P206298

Band width 1.5" (38mm)

